



KICKER



KX AMPLIFIERS

WIN LOUD

OWNER'S MANUAL

KX350.2, KX450.2, KX550.2, KX850.2

STEREO AMPLIFIERS

KICKER®

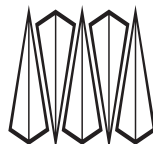

**KX.2 Series
Amplifier
Owner's Manual**

Two Channel Models: KX350.2 / KX450.2 / KX550.2 / KX850.2

Attention:

Please record your purchase information in the area below. We recommend attaching the original sales receipt to this manual for future reference.

If you require service on this speaker during the warranty period, you will need to provide this information and a copy of the original sales receipt to Kicker for validation of warranty repairs.

ALWAYS KEEP YOUR RECEIPT!

Congratulations!

You have just purchased the latest in amplifier technology to carry the famous KICKER name. Your KICKER KX series amplifier is designed and built to give you years of powerful and trouble-free performance. This installation manual contains valuable information on how to get the most out of your new KX series amplifier.

This is your "fuel for Livin' Loud™"!

Authorized Kicker Dealer: _____

Purchase Date: _____

Amplifier Model Number: _____

Amplifier Serial Number: _____

FEATURES

Low Impedance Operation Class A/B stable into 2 ohm stereo or 4 ohm mono loads.

SHORT Protection Circuitry (Short circuit, Over-voltage, Reverse polarity, Thermal) Protects amplifier from accidents and undesirable operation.

MOSFET Power Supply Provides high efficiency operation.

KickBass Variable bass boost circuit which provides up to 18dB of boost at 40Hz.

Built-In Variable Crossover 12dB selectable High pass or Low pass variable from 50-200Hz. User defeatable for full range operation.

High & Low level inputs Allows connection to various sources such as: after-market stereo, factory radio, DVD Player, Video Cassette Player, etc.

PAST (PRE Amp Signal Transfer) Output RCA jacks to pass the incoming signal to another amplifier or component.

Custom tooled gold plated connectors Assure maximum power transfer and clamping.

SAMS (Stereo And Mono Simultaneously) Amplifiers will operate into a bridged mono load and a stereo load at the same time.

Remote Bass Level Control Dash or center console mountable for remote fine-tuning of bass output.

EndKaps Cast aluminum, custom, removable covers to protect and hide all your wiring connections to the amplifier. Can be prepped and painted any custom color you choose.

Two Year Warranty When *purchased from an Authorized KICKER Dealer.*

MOUNTING

When selecting a location to mount your Kicker amplifier be sure it is structurally sound and that there are no items behind the area where the screws will be driven that could be damaged. Check for wire harnesses, brake lines, fuel lines, gas tanks, etc.

All amplifiers generate heat under normal operation. Be sure to choose a location that allows adequate ventilation for the amplifier. Also consider that the air temperature inside an automobile's luggage compartment can reach upwards of 140° Fahrenheit (60° Celsius). An amplifier mounted here may require additional cooling tactics such as fans or venting ducts to the passenger compartment to allow cool operation. If possible, mount the amplifier in the climate-controlled passenger compartment.

Remove

Remove

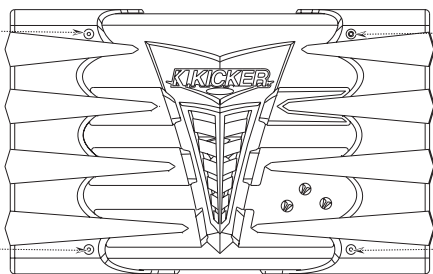

Remove

Remove

Remember the controls on top of the amplifier will need to be accessible for adjustment. Keep this in mind as you choose your amplifier's mounting location.

Now that you are ready to mount your amplifier, use the supplied 3mm allen wrench to remove the amplifier EndKap. This will give you access to the mounting holes in the amplifier and all wiring connections.

With the EndKap removed, drill four holes using a 7/64" (11mm) drill bit and use the supplied #8 screws to mount the amplifier.

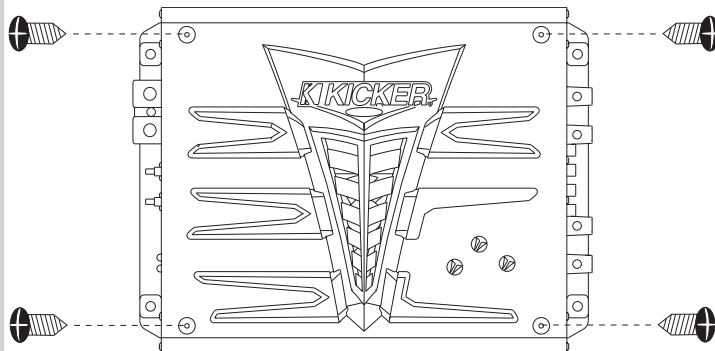

Use supplied #8 Mounting Screws

WIRING

Signal can be input into the amplifier using either the low level RCA input connections or the high level (speaker level) input connections. Using the low level RCA connections is the preferred method. Use the high level inputs only if your source unit does not have low level RCA type outputs. Connecting to the amp with either input connection will provide a low level signal at the output (**PAST**) RCA jacks.

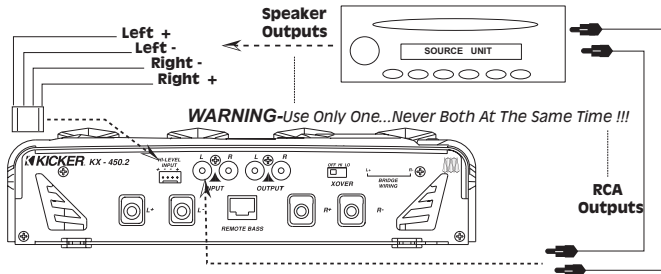

The use of twisted pair interconnects is recommended for all installations to minimize noise. When routing these cables through the automobile, try to keep them away from factory wiring harnesses and other power wiring. If you need to cross any of this wiring do so at a 90 degree angle to reduce the potential of alternator noise and electrical interference.

When working with power connections it is always recommended that you disconnect the battery to prevent accidents.

The ground should be connected to the amplifier first before making any of the other connections. This wire should be as short as possible (24 inches or less) and connected to a paint- and corrosion-free solid metal area of the car's chassis. Use the same gauge wire as recommended for the amplifier's power connection to the battery. Adding an additional ground wire between the car battery's negative post and the car chassis of this same gauge (or larger) is also recommended.

If you ever need to remove the amplifier from the vehicle after it has been installed, the ground wire should be the last wire disconnected from the amplifier--just the opposite as when you installed it.

A fuse must be installed within 18 inches of the battery to protect the power wire feeding your amplifier. This fuse should be of at least the same value used in the amplifier but no higher than the capacity of the wire. See the chart below for wire size and fusing recommendations.

Model	Fuse Size	Wire Size
KX350.2	50A	8 GA
KX450.2	60A	4 GA
KX550.2	70A	4 GA
KX850.2	120A	2 GA

Note: To get the best performance from your new Kicker Amplifier, we recommend using *genuine* Kicker Accessories and Wiring.

Remote Bass Level

When the crossover on your KX series amplifier is set to **LOW PASS**, you have the ability to control the output level of the amplifier from the driver's seat using the supplied Remote Bass Level Control.

To mount the controller simply screw the metal bracket to the chosen location, then slide the housing onto the bracket until it snaps into place.

Run the cable from the controller to the "Remote Bass" jack on the amplifier chassis.

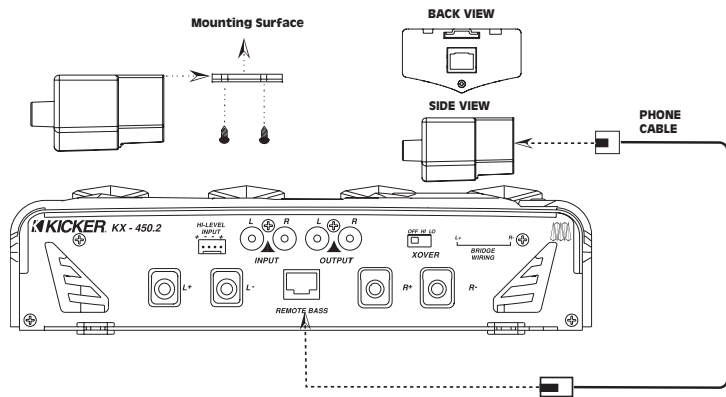

USING THE SIGNAL OUTPUT JACKS (PAST)

The Output (Pre Amp Signal Transfer) RCA jacks allow you to send the incoming signal from one Kicker KX series amplifier to another amplifier or processor without the need for Y cables. The signal from the **PAST** jacks is identical to the signal fed to the amplifier via its RCA input jacks or the High Level inputs and is not affected by the amplifier's built in crossover.

Most head units with high voltage outputs should be capable of driving up to ten amplifiers in a chain.

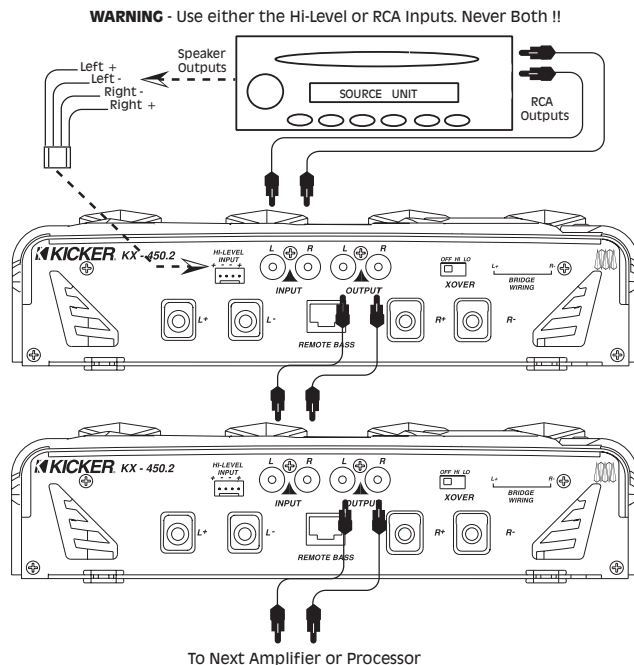

SYSTEM DIAGRAM

The following diagrams show the most common configurations for your Kicker KX series amplifier.

TWO CHANNEL OPERATION (STEREO)

KX.2 series amplifiers are capable of operating into a minimum impedance of 2 ohms per channel in stereo operation.

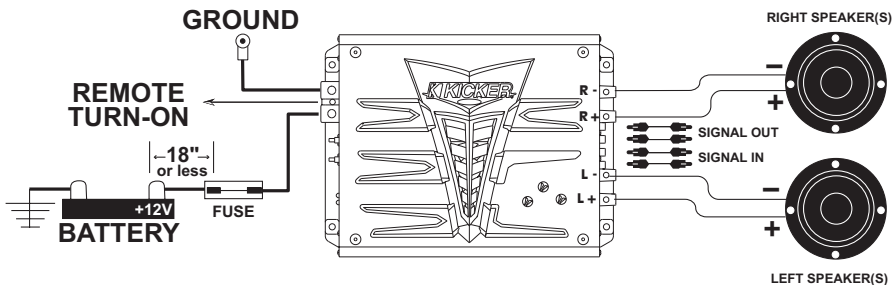

BRIDGED OPERATION (MONO)

KX.2 series amplifiers are capable of operating into a minimum impedance of 4 ohms when in bridged operation.

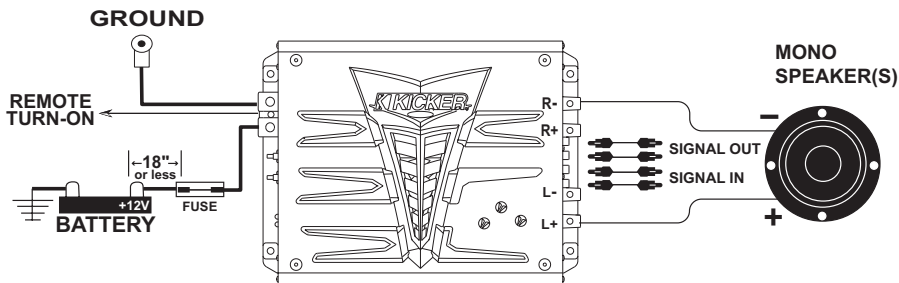

SYSTEM DIAGRAM

STEREO AND MONO SIMULTANEOUSLY (SAMS)

KX.2 series amplifiers are capable of operating into a minimum impedance of 4 ohms mono and 2 ohm stereo simultaneously with the use of passive crossovers.

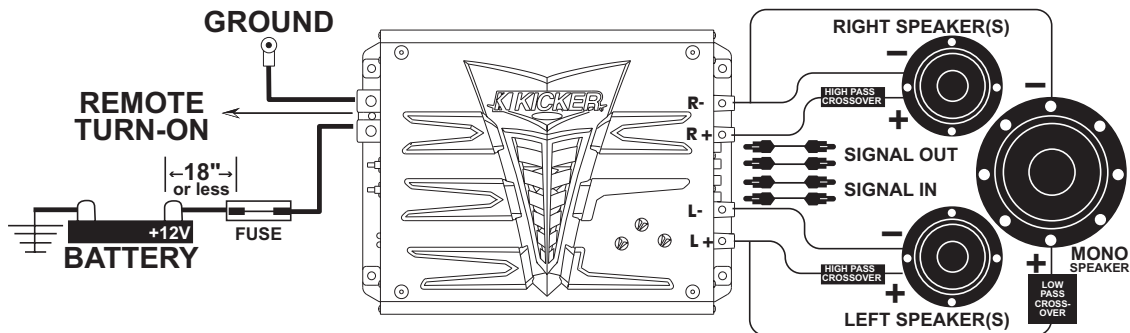

On your Kicker amplifier there are three rotary controls on top and one switch on the end panel. These controls ensure the reliability and performance of the amplifier, so they need to be set correctly.

CROSSOVER SWITCH **NEVER CHANGE THE CROSSOVER SWITCH SETTING WITH THE SYSTEM ON!**

The switch located on the end panel next to the RCA jacks is for setting the internal crossover. In the OFF position the amplifier passes a full range signal to the speakers. Use the LO position when connected to a subwoofer. The HI position should be selected when connected to any speakers which you do not want to receive sub-bass information.

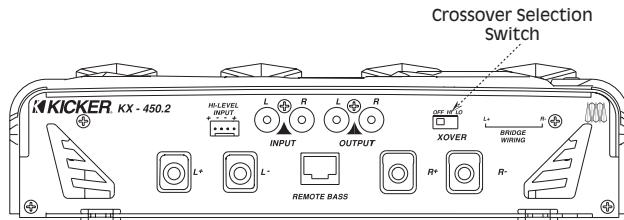

BEFORE TURNING ON THE SYSTEM FOR THE FIRST TIME, MAKE SURE THAT THE THREE ROTARY CONTROLS ON TOP OF THE AMPLIFIER ARE TURNED FULLY COUNTER-CLOCKWISE!

GAIN CONTROL

Remember, the gain control is not a volume control, it matches the output of the head unit to the input level of the amplifier and must be adjusted properly for best performance. All the way up or down is not necessarily the best. Turn the head unit up to about 3/4 volume. (eg. If the head unit goes to 30, turn it to 25.) Next, turn (clockwise) the gain on the amplifier up slowly until you can hear audible distortion, then turn it down just a little.

Crossover Control

Where you set the crossover is very subjective and can be fine tuned to match your listening preference or speaker requirements.

Bass Boost

The BASS BOOST control is designed to give you increased output at 40 Hz. The setting for this control is subjective, however, if you turn it up, you must go back and adjust the gain control to avoid clipping the amplifier.

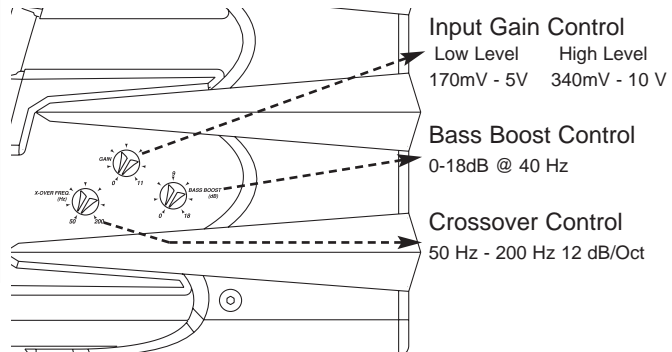

TROUBLESHOOTING

If your amplifier does not appear to be working, check obvious things first such as blown fuses, poor or incorrect wiring connections, incorrect setting of crossover switch and gain controls, etc.

There are two LEDs on the end panel of your Kicker KX series amplifier, one green and one red. When the green LED is lit this indicates the amplifier is turned on and no trouble exists. If the green LED turns off and the red LED is lit this indicates that the protection circuitry (**SO**RT) is engaged.

The power indicator on top of the amplifier which illuminates the model badge follows the same function as the green LED.

○ Green LED off, no output:

With a Volt Ohm Meter (VOM) check:

- ⇒ +12 volt power terminal (should read +12V to +16V).
- ⇒ Remote turn-on terminal (should read +12V to +16V).
- ⇒ Ground terminal.

○ Green LED on, no output:

- ⇒ Check RCA connections.
- ⇒ Test speaker outputs with known good speaker.
- ⇒ Substitute known good source unit.
- ⇒ Check for signal on RCA cable with VOM meter in AC position.

○ Red LED on, no output:

- 1.) Amp is very hot.
 - ⇒ Thermal protection is engaged. Check for proper impedance at speaker terminals. Also check for adequate airflow around amplifier.
- 2.) Amp shuts down only while vehicle is running.
 - ⇒ Voltage protection is engaged. Voltage to the amplifier is not within the 9-16 volt operating range. Have automobile charging/electrical system inspected.
- 3.) Amp will only play at low volume levels.
 - ⇒ Short circuit protection is engaged. Check for speaker wires shorted to each other or the vehicle chassis. Damaged speakers or operating below minimum impedance will also cause this.

○ No output from one channel:

- ⇒ Check balance control on head unit.
- ⇒ Check RCA & speaker connections for that channel.
If problem changes sides then you have a bad RCA cable or source unit problem.
- ⇒ Swap speaker connections from left to right.
If problem changes sides then you have a bad speaker cable or bad speaker.

○ Alternator noise (whining sound that varies with engine RPM):

- ⇒ Check for damaged RCA cable.
- ⇒ Check routing of RCA cable.
- ⇒ Check source unit for good ground.
- ⇒ Check gain setting, turn down if set too high.
- ⇒ Swap RCA connections from left to right.

TROUBLE SHOOTING

○ Poor stereo image or reduced bass response:

⇒ Check system phasing by turning the balance control from left to right. If there is more bass output when turned to either side then check your speaker wiring for proper positive and negative connections. Reverse connections on one channel if necessary.

CAUTION: When jump starting the vehicle, be sure that connections made with jumper cables are correct. Improper connections can result in blown amplifier fuses as well as failure in other systems in the vehicle.

Please Note: Modern high performance speakers have a lower DC Resistance than what used to be available. The Kicker Coaxial and Component Speakers are rated at four ohms (some DC Resistances may be as low as 3 ohms) and work with any amplifier designed to operate at a four ohm load. If you want to use two Kicker Coaxial or Component Speakers on a single channel of your amplifier wire the speakers in series. This will improve the sound quality, lower the total harmonic distortion and lessen the thermal load at the amplifier. This may prevent an amplifier from shutting down, due to over-current protection circuitry.

If you have more questions about the installation and operation of your new **KICKER** amplifier, see the Authorized **KICKER** Dealer in your area. You may also call our Technical Services Line at (405) 624-8583 for assistance or visit our website at www.KICKER.com.

NOTE: All specifications and performance figures are subject to change. Please visit the support section at www.kicker.com for the most current information.

Performance

Model	KX350.2	KX450.2	KX550.2	KX850.2
RMS Power in Watts, All Channels Driven				
@ 14.4V, 4Ω Stereo, ≤ 1% THD+N	110 x 2	150 x 2	205 x 2	295 x 2
@ 2Ω Stereo, ≤ 1% THD+N	175 x 2	225 x 2	275 x 2	425 x 2
@ 4Ω Mono, ≤ 1% THD+N	350	450	550	850
@ 12.5V, 4Ω Stereo, 0.085% THD+N	70 x 2	90 x 2	115 x 2	180 x 2
@ 2Ω Stereo, 0.5% THD+N	135 x 2	180 x 2	230 x 2	360 x 2
@ 4Ω Mono, 0.5% THD+N	265	360	420	650
Length With EndKaps	16" (40.64cm)	19.25" (48.90cm)	22.5" (57.15cm)	25.75" (65.41cm)

SPECIFICATIONS COMMON TO ALL MODELS

Height:	2.5 inches / 6.35 centimeters
Width:	10.125 inches / 25.7 centimeters
Length Without EndKaps:	Subtract 5" (12.7cm) from chart above
Frequency Response:	20Hz - 20kHz, + 0 /- 1dB
Input Sensitivity:	170mV - 5V low level, 340mV - 10V high level
Signal-to-Noise Ratio:	>95dB, a-weighted, re: rated power
Electronic Crossover:	Variable high or low pass, 50 - 200Hz, 12dB/octave
KickBass Boost:	Variable 0 to +18dB boost @ 40Hz

**Model KX350.2**

110 x 2 @ 4 ohms, 14.4Vdc, 1% THD, CEA-2006 (Watts)
Signal to Noise Ratio -98
CEA-2006 (ref: 1W, A-weighted)

Model KX450.2

150 x 2 @ 4 ohms, 14.4Vdc, 1% THD, CEA-2006 (Watts)
Signal to Noise Ratio -95
CEA-2006 (ref: 1W, A-weighted)

Model KX550.2

205 x 2 @ 4 ohms, 14.4Vdc, 1% THD, CEA-2006 (Watts)
Signal to Noise Ratio -95
CEA-2006 (ref: 1W, A-weighted)

Model KX850.2

295 x 2 @ 4 ohms, 14.4Vdc, 1% THD, CEA-2006 (Watts)
Signal to Noise Ratio -93
CEA-2006 (ref: 1W, A-weighted)

ELECTRONICS LIMITED WARRANTY

Kicker warrants this product to be free from defects in material and workmanship under normal use for a period of **THREE (3) MONTHS** from date of original purchase with receipt. When purchased from a Authorized KICKER Dealer it is warranted for **TWO (2) YEARS** from date of original purchase with receipt. In all cases you **must have the original receipt!** Should service be necessary under this warranty for any reason due to manufacturing defect or malfunction during the warranty period, Kicker will repair or replace (at its discretion) the defective merchandise with equivalent merchandise at no charge. Warranty replacements may have cosmetic scratches and blemishes. Discontinued products may be replaced with more current equivalent products.

This warranty is valid only for the **original purchaser** and is not extended to owners of the product subsequent to the original purchaser. Any applicable implied warranties are limited in duration to a period of the express warranty as provided herein beginning with the date of the original purchase at retail, and no warranties, whether express or implied, shall apply to this product thereafter. Some states do not allow limitations on implied warranties, therefore these exclusions may not apply to you. This warranty gives you specific legal rights; however you may have other rights that vary from state to state.

WHAT TO DO IF YOU NEED WARRANTY OR SERVICE

Defective merchandise should be returned to your local Authorized Stillwater Designs (Kicker) Dealer for warranty. Assistance in locating an Authorized Dealer can be found at www.kicker.com or by contacting Stillwater Designs directly. You can confirm that a dealer is authorized by asking to see a current authorized dealer window decal.

If it becomes necessary for you to return defective merchandise directly to Stillwater Designs (Kicker), call the Kicker Customer Service Department at (405)624-8510 for a Return Authorization (RMA) number. Package all defective items in the original container or in a package that will prevent shipping damage, and return to

Stillwater Designs, 5021 North Perkins Road, Stillwater, OK 74075

The RMA number must be clearly marked on the outside of the package. Please return **only defective components**. The return of functioning items increases your return freight charges. Non-defective items received will be returned freight collect.

Include a copy of the original receipt with the purchase date clearly visible, and a **“proof-of-purchase”** statement listing the Customer's name, Dealer's name and invoice number, and product purchased. Warranty expiration on items without proof-of-purchase will be determined from type of sale and the manufacturing date code. Freight must be prepaid; items sent freight collect, or COD, will be refused.

Failure to follow these steps may void your warranty. Any questions can be directed to the Kicker Customer Service Department at (405) 624-8510.

WHAT IS NOT COVERED?

This warranty is valid only if the product is used for the purpose for which it was designed.

It does not cover:

- Damage due to improper installation.
- Subsequent damage to other components.
- Damage caused by exposure to moisture, excessive heat, chemical cleaners, and/or UV radiation.
- Damage through negligence, misuse, accident or abuse. Repeated returns for the same damage may be considered abuse.
- Any cost or expense related to the removal or reinstallation of product.
- Speakers damaged due to amplifier clipping or distortion.
- Items previously repaired or modified by any unauthorized repair facility.
- Return shipping on non-defective items.
- Products with tampered or missing barcode labels.
- Products returned without a Return Authorization (RMA) number.
- Freight Damage.
- The cost of shipping product to Kicker.
- Service performed by anyone other than Kicker.

HOW LONG WILL IT TAKE?

Kicker strives to maintain a goal of 72-hour service for all electronics (amplifiers, crossovers, equalizers, etc.) returns. Delays may be incurred if lack of replacement inventory or parts is encountered.

INTERNATIONAL WARRANTY

Contact your International Kicker dealer or distributor concerning specific procedures for your country's warranty policies.



STILLWATER
Designs

P.O. Box 459 • Stillwater, Oklahoma 74076 • U.S.A. • 405 624-8510

WARNING:

KICKER drivers are capable of producing sound levels that can permanently damage your hearing! Turning up a system to a level that has audible distortion is more damaging to your ears than listening to an undistorted system at the same volume level. The threshold of pain is always an indicator that the sound level is too loud and may permanently damage your hearing.
Please use common sense when controlling volume!



PIZZA DELIVERY #'S

HOOKUPS

NOTES



